



**AGGREGATE**  
INDUSTRIES



## **Bradstone roofing**

- technical data

# Roofing technical data

The continued decline of stone slate quarrying has been followed by an increasing dependence on second-hand slates with a questionable further life expectancy. Sourcing reclaimed natural stone roofing is becoming increasingly difficult and expensive.

The Bradstone roofing range is a readily available, highly acceptable reconstructed stone alternative, which retains the essential characteristics of the original natural stone slates from which it is moulded.

Ease of laying with no need for sorting or redressing enables the traditional stone roof appearance to be kept alive at a relatively low cost.

## Contents

Introduction	02
Battening and coursing	04
Eaves and vertical slating	08
Change in roof pitch and abutments	09
Hips	10
Verges	11
Valleys	12
Ridge tile and slate ventilators	14
Gas flue ridge terminal	16
Fixing information	17

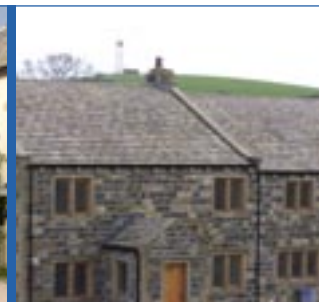

# Roofing

## technical data

### Composition

The Bradstone range of roofing slates is manufactured principally from naturally occurring aggregates, ordinary Portland cement and colouring pigments. They are moulded from hand-dressed natural stone slates by means of a specially developed technique which reproduces the fine detail of the originals on the textured face. A range of masters is used to avoid noticeable repetition of profiles. All Aggregate Industries roofing slates comply with BS EN 490:1994 (Concrete Roofing Tiles and Fittings - Product Specifications). Product testing is carried out in accordance with BS EN 491:1994 (Concrete Roofing Tiles and Fittings - Test Methods). These tests cover important properties of the tiles including freeze thaw resistance, impermeability and transverse strength.

### Good roofing practice

The following is intended as a general guide to good roofing practice in relation to Aggregate Industries roofing slates.

All roofing design and installation should be in accordance with the recommendations of BS 5534 'Slating and Tiling'.

Our technical services department is happy to provide assistance on any specific aspect of roofing with Aggregate Industries roofing slates.

### Weathering

The nature, extent and visible effects of weathering will depend upon the location, degree of exposure and prevailing weather conditions and the effectiveness of the architectural detailing.

Bradstone roofing products will weather as much as indigenous natural stone exposed to the same conditions.

### Corporate

#### Aggregate Industries

The Bradstone range of roofing products is manufactured by Aggregate Industries. We are a premier supplier of reconstructed stone roofing and architectural masonry products and offer highly aesthetic products which are tried and tested in the market place. This range includes roof tiles and a range of architectural dressings to complement walling products.

#### Aggregate Industries

Aggregate Industries is an international aggregate, construction and building materials group, based in the UK, and was incorporated into the Swiss Holcim Group in April 2005. The group has leading regional market positions in the UK, as well as operations in the Channel Islands and Norway.

Aggregate Industries also manufacture and supply commercial architectural masonry products and the Charcon range of hard landscaping products.

#### Manufacturing standards

The Bradstone roofing range is manufactured using a wet cast reconstructed stone product and is compliant to European Standard BS EN 490. Produced in the UK, with locally sourced materials under strict environmental and social legislation, for local supply.

All Aggregate Industries' products are manufactured in accordance with ISO 9001 with factory compliance to ISO 14001.

#### Sustainability and local sourcing

**Energy use:** Aggregate Industries is at the forefront of sustainability and has committed to reduce carbon emissions by 20% by 2012 based on a base line.

**Recyclable:** 100% of the products can be recycled thus reducing the amount of material that is sent to landfill.

**Responsible sourcing:** Aggregate Industries is the first company in the world to achieve a BES 6001:2008 Responsible Sourcing Certificate from BRE Global. Products are assessed on:

- quality management
- environmental management
- health and safety management
- greenhouse gas emissions
- minimising raw material usage
- labour practise
- biodiversity
- community engagement.

#### Key aggregate and recycled content

The Bradstone roofing range is manufactured principally from naturally occurring aggregates, ordinary Portland cement and colouring pigments, cast in moulds.

#### Policies

Aggregate Industries' policies on the environment and community, health and safety and sustainable solutions for different product applications can be viewed on our website [www.aggregate.com](http://www.aggregate.com)



OHS61759



FMS96927



EMS96928

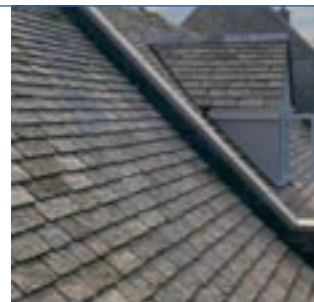

# Battening and coursing

## Slate sizes

To achieve the authentic appearance of traditional stone roofing, Bradstone roofing slates are manufactured in a range of lengths, which are laid in the traditional manner of diminishing courses and random widths.

The longer slates are laid at the eaves, the shorter slates at the ridge.

Battening is therefore not set out at equal centres over the whole height of the roof, but is gauged to take account of the diminishing length of the slates.

Crofters Slates have been developed as single size stone effect roofing slates that achieve a traditional appearance without the need for diminishing courses.

## Battening

With every order we schedule the quantities of Bradstone roofing slates and fittings required and supply a battening and coursing guide which relates to the particular roof to be covered.

The battening and coursing guide is as accurate as we can make it from the information supplied, but should be carefully checked against actual rafter lengths and site dimensions before the slates are delivered. Thus any necessary adjustments, to the battening gauges or to the coursing and quantities of materials, may be made prior to delivery of materials to site.

## Crofters Slates

A typical battening gauge detail for slates laid to standard 80mm head lap is shown below.

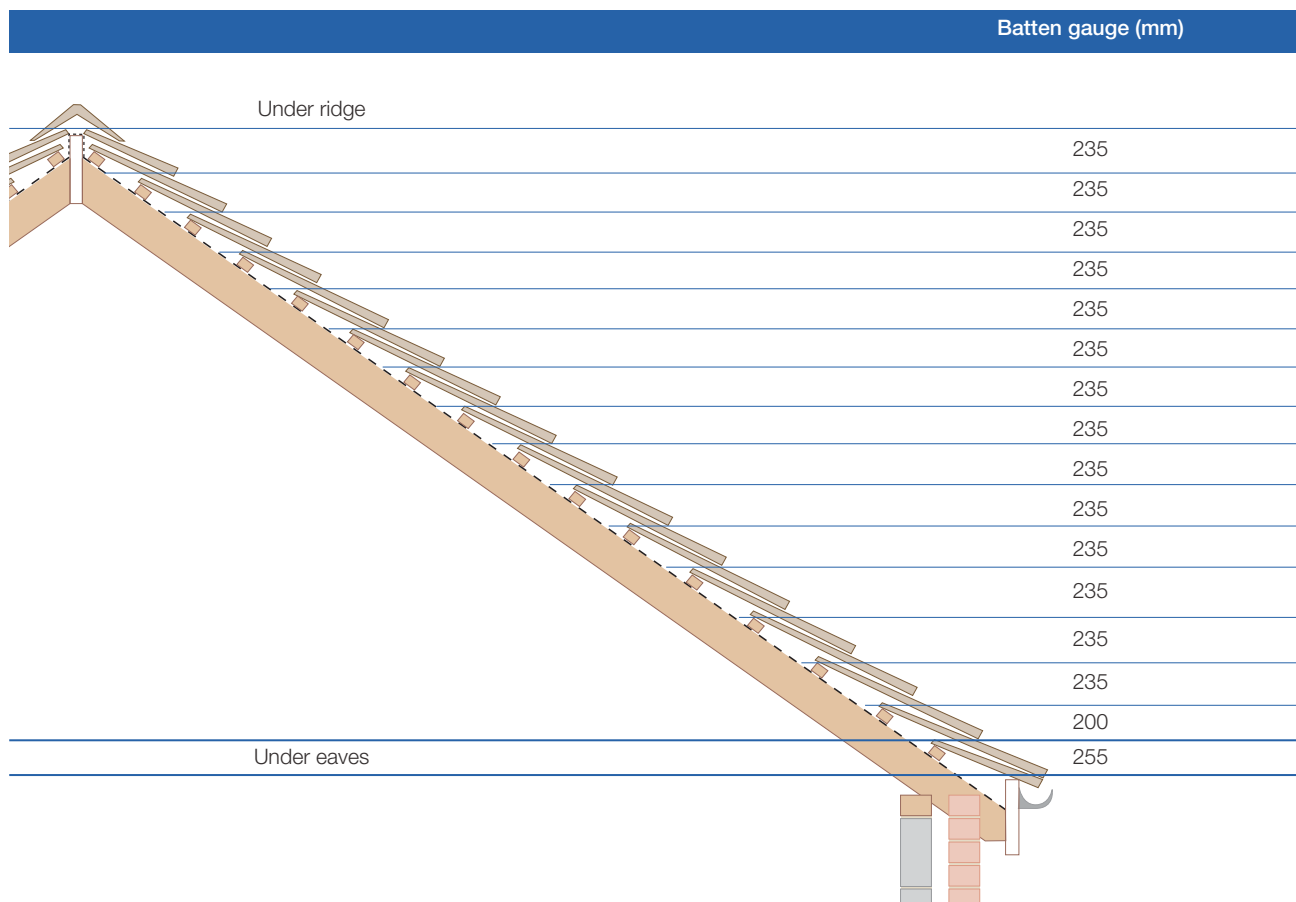

# Battening and coursing

## Coursing

The basic slate lengths, six in the Bradstone Cotswold range, eight in the Bradstone Conservation range and three in the Bradstone Old Quarried range, are each supplied in sufficient quantity to cover approximately equal increments of rafter length.

## Old Quarried Slates

A typical battening gauge detail for slates laid to standard 80mm head lap is shown below.

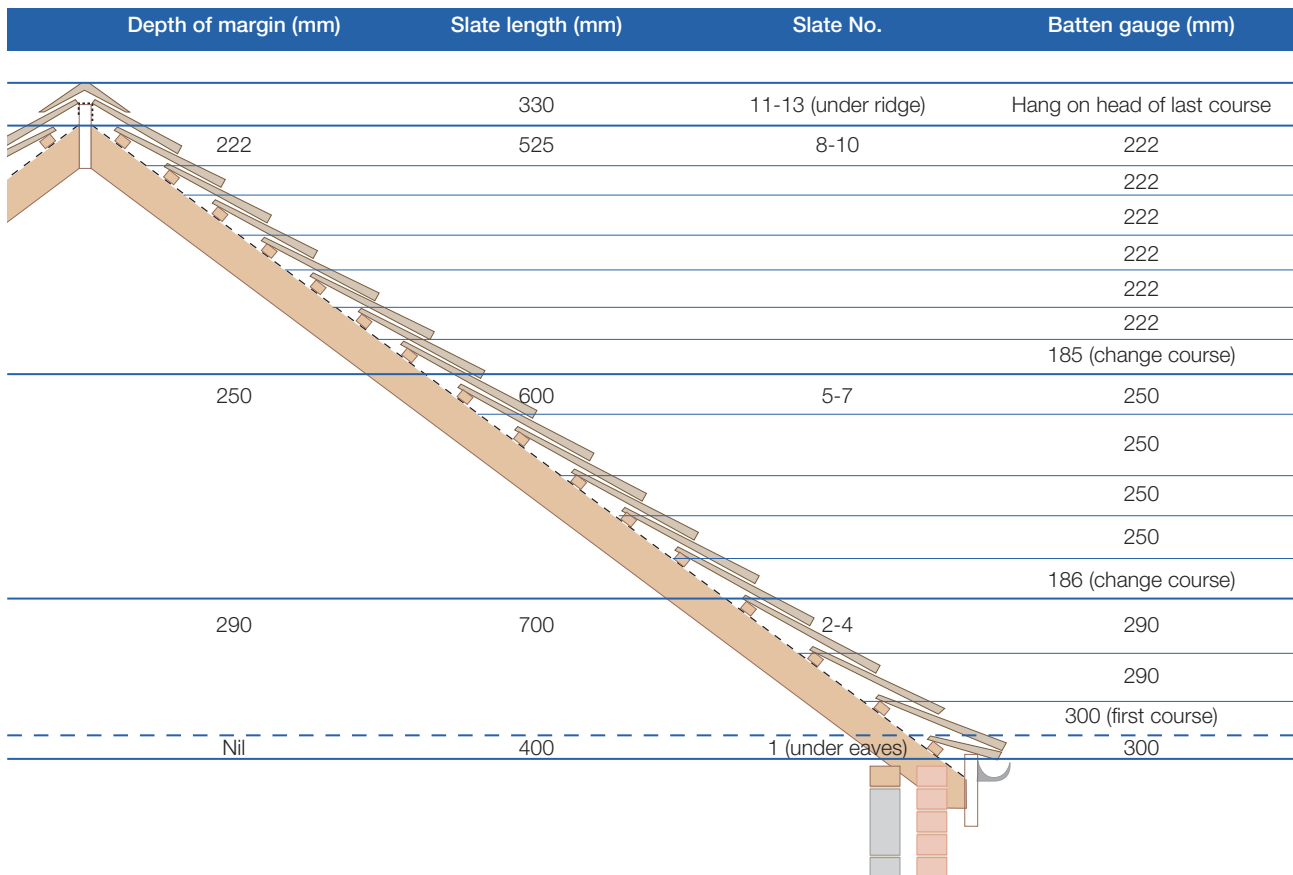

# Battening and coursing

## Conservation Slates

A typical battening gauge detail for slates laid to standard 80mm head lap is shown below.

Depth of margin (mm)	Slate length (mm)	Slate No.	Batten gauge (mm)
	203	M	Hang on head of last course
90	254	J	90
			90
			90
			90
			70 (change course)
100	279	H	100
			100
			100
			85 (change course)
110	305	G	110
			110
			95 (change course)
125	330	F	125
			125
			100 (change course)
140	356	E	140
			140
			110 (change course)
160	406	D	160
			160
			130 (change course)
185	457	C	105
			165 (change course)
			215
215	508	B	200
Nil	305	A1 (under eaves)	210

# Battening and coursing

## Cotswold Slates

A typical battening gauge detail for slates laid to standard 80mm head lap is shown below.

Depth of margin (mm)	Slate length (mm)	Slate No.	Batten gauge (mm)
	200	30-33 (under ridge)	Hang on head of last course
115	300	1-5	115
			115
			115
			115
			115
			90 (change course)
135	350	6-9	135
			135
			135
			135
			110 (change course)
160	400	10-13	160
			160
			160
			135 (change course)
185	450	14-18	185
			185
			160 (change course)
210	500	19-23	210
			105 (change course)
		24-28	235
235	550		200
Nil	350	29 (under eaves)	255

# Eaves and vertical slating

## Eaves

All the Bradstone roofing ranges include an under eaves slate supplied specifically to achieve a traditional stone eaves detail.

The under eaves slates are fixed bed upwards so that the moulded surface may be seen from the ground.

### Detailing

The appropriate standard under eaves slate is supplied unless otherwise specified; this provides an eaves oversail of between 60-80mm depending on pitch.

### Eaves ventilation

Standard proprietary eaves ventilation units may be used with all Bradstone roofing ranges, or eaves ventilation may be provided via drilled holes in the fascia board.

## Vertical slating

Due to the thickness of the slates, the Bradstone Old Quarried and Crofters ranges are not recommended for vertical application.

Bradstone Cotswold and Conservation Slates must be fixed in accordance with BS 5534: 2014. Using two Aluminium nails of a minimum 2.65mm diameter in accordance with BS 1202-3 in each tile, penetrating at least 20mm into the batten.

At the top edge use nailed under ridge slates; where under a window cill or soffit, dress with a lead flashing.

The bottom edge should have double coursing using an under eaves slate and tilting fillet.

At abutments maintain a broken bond, cutting slates as necessary closely in to the abutment. Fix lead flashing turned behind slates.

At angles, cut slates as necessary and provide lead soakers in each slate course.

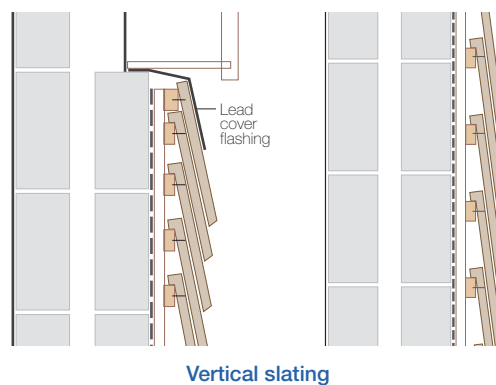
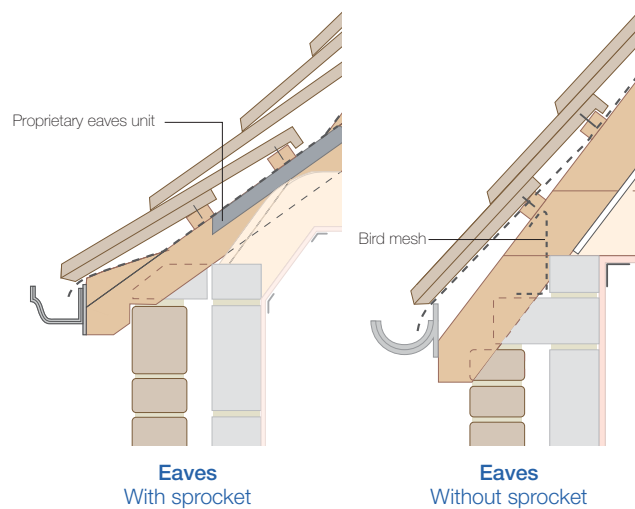
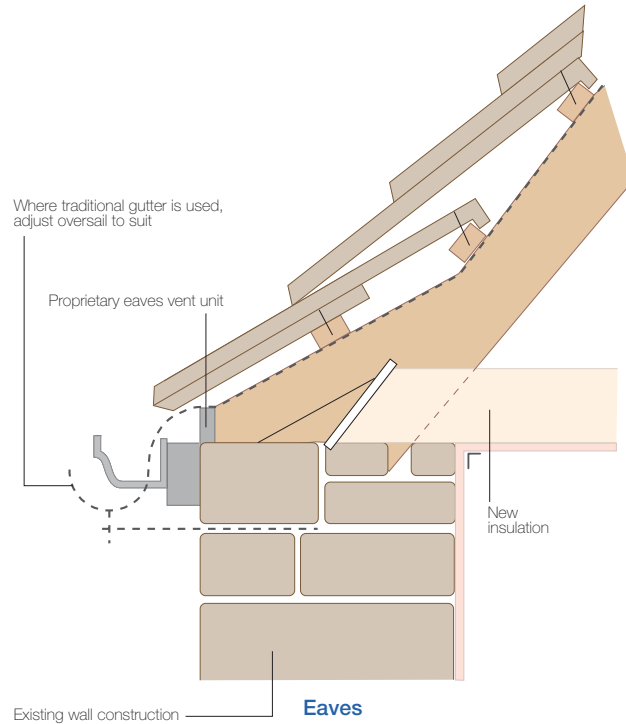



# Change in roof pitch and abutments

## Change in roof pitch

For a change in pitch lay slates on boarding with a tilting fillet at top edge and dress with code 5 lead flashing as illustrated.

## Abutments

### Sloping edge

Cut widest size slates only as necessary and fit slates closely into the abutment. Fix lead soakers to each course by turning down over the head of each slate and dress cover flashing neatly down over soakers.

### Top course

Hang under-ridge slate on last main course. Cover with lead soaker and flashing wedging at 450mm centres.

### Box gutters

Fix code 4 lead flashing wedges at laps and at 450mm centres.

### Parapets

Fix code 4 lead flashing in 1.5 - 2.0m lengths, wedged at laps and every 450mm centres.

### Dormer window

All abutments to be treated as mitred valley detail (page 12), with cut slates interleaved with lead soakers. Only 300 or 305mm length slates should be used on dormer cheeks (Bradstone Old Quarried and Crofters Slates are not appropriate for vertical slate hanging).

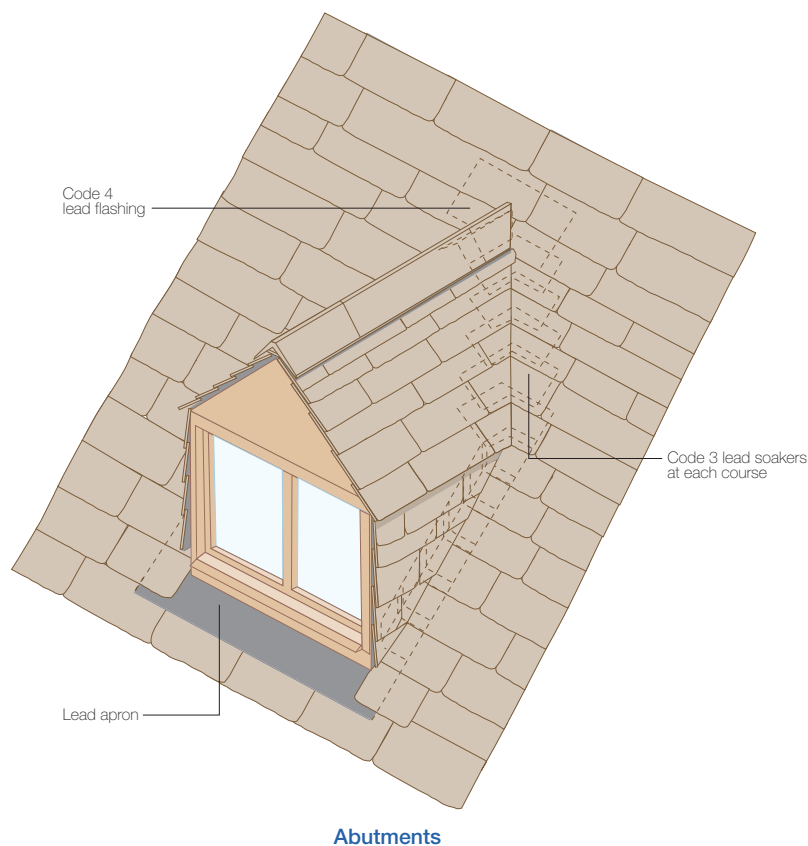
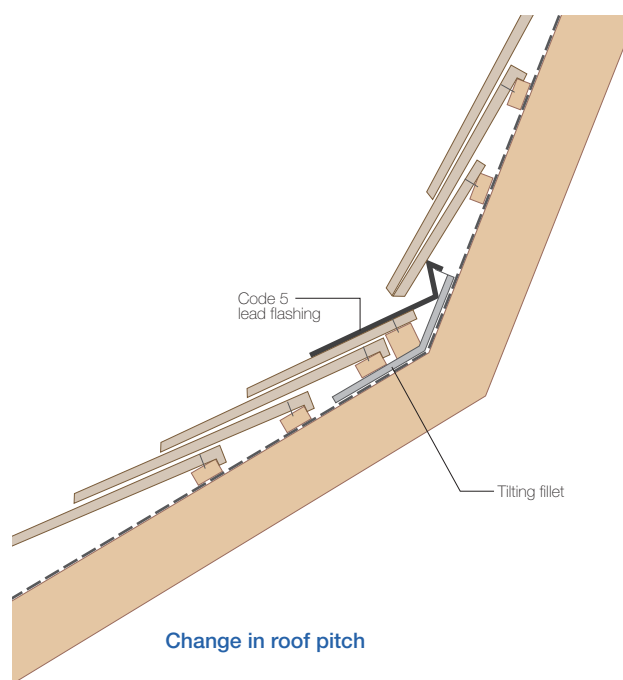

## Hips

Hips may be formed using the appropriate hip unit or by using a mitred hip detail.

Note: In all cases only the widest size slates should be cut.

### Capped hip

Each hip tile is to be mechanically fixed with a 4.5mm diameter screw, penetrating at least 35mm. Fix 6mm galvanised hip irons at the foot of each hip rafter using two 12 gauge galvanised screws or nails. Cut slates to fit closely at junction and make weathertight with hip units laid to a true line with edges and joints solidly bedded in mortar as the work proceeds. Shape first hip unit to align with corner of eaves and fill end with mortar and slips of slate finished flush.

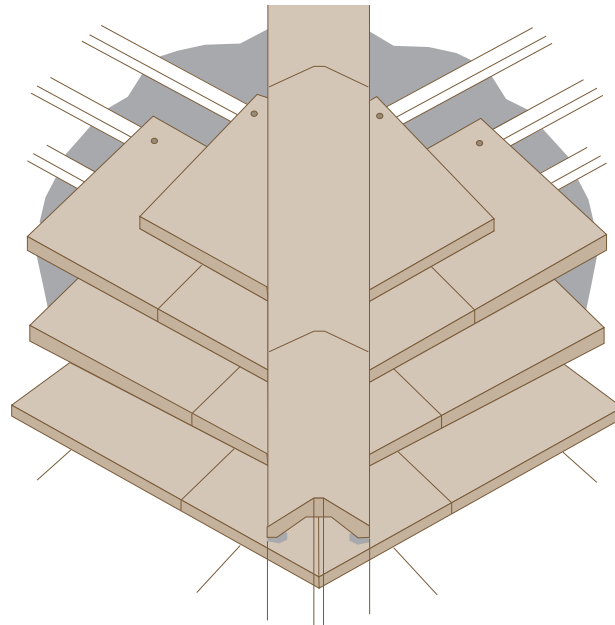

Capped hip

### Mitred hip

#### (a) Lead soaked

Cut slates neatly, accurately and interleave with code 4 lead soakers to form a straight, weathertight, close-mitred junction. Dress soakers over the head of each course of slates.

#### (b) Lead soaked and mortar roll

In the case of the Bradstone Cotswold and Conservation roofing slates, a further traditional appearance can be achieved by mitring and soaking as (a) above, but with the addition of a mortar cap or roll being used to cover the full length of the mitred hip unit.

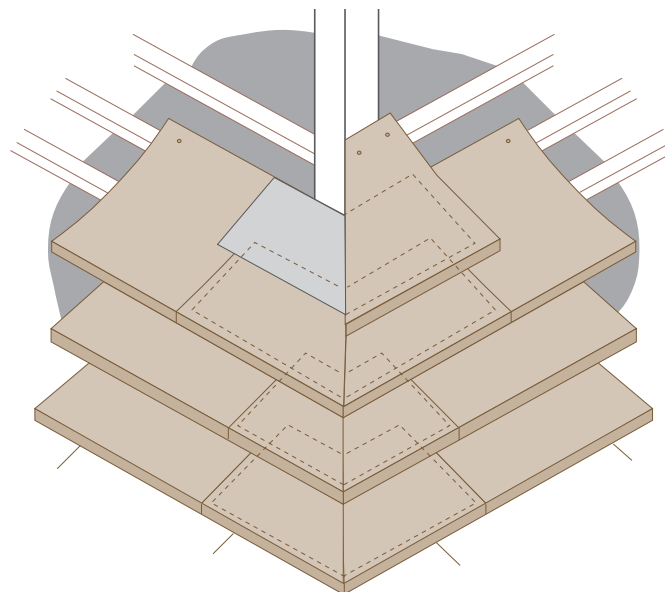

Mitred hip

## Verges

The thinner Bradstone Cotswold and Conservation ranges may be laid with or without under-cloak. Bradstone Old Quarried and Crofters roofing slates are traditionally laid with an under cloak.

For all slate ranges, a 'struck off' detail may be used if required.

With either method of construction, verges must be fully bedded in with mortar as work progresses.

### Under-cloak

Suitable strips, cut from the moulded portion of the slates, are bedded in mortar to give a normal oversail of about 45mm from the face of the building.

The under-cloak is laid bed upwards so that the moulded surface is seen when viewed from the ground.

### Struck off

A 'struck off' detail will achieve the traditional dog-toothed effect of natural stone slates when laid without an under-cloak.

The outer shoulder of the head of each Bradstone slate is struck off to a varying angle as it is being laid up the verge. An oversail of approximately 45mm should be provided.

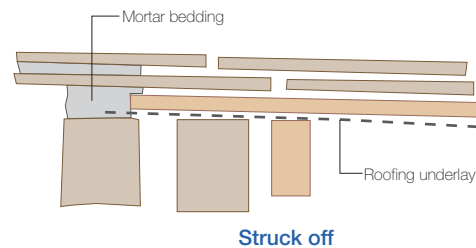
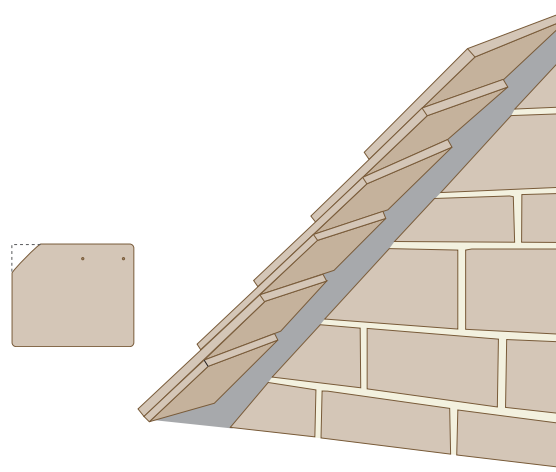
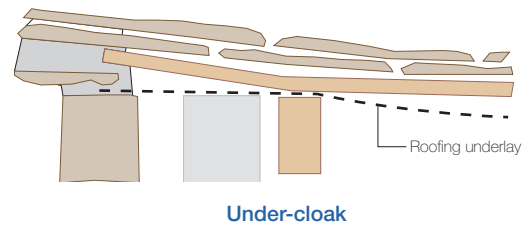
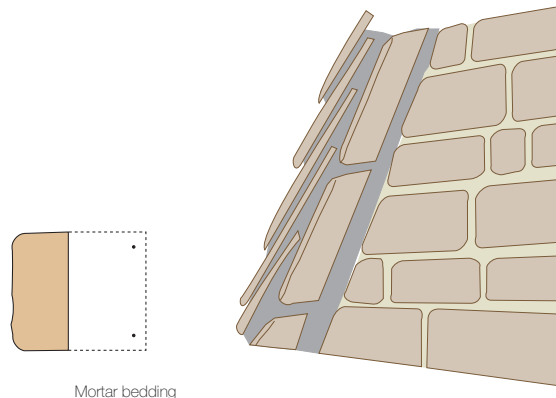

# Valleys

## Valleys

Close mitred and lead lined open valleys may be formed in the Bradstone Cotswold, Crofters, Old Quarried and Conservation ranges. It is possible to form a swept valley in Bradstone Cotswold and Conservation slate ranges.

### Close mitred valley

Cover with an underlay strip 1m wide, underlapping general underlay. Cut slates neatly and accurately and interleave with lead soakers to a straight, close, weathertight mitred junction. Dress soakers over the head of each course of slates.

### Open valley

Line gutter with code 5 lead dressed over triangular timber fillets. Support lead lining and fillets on timber valley boards (minimum 225x19mm). Cut required slates to rake and bed edges in mortar.

### Swept valley

A range of centre slip slates are produced to suit the Bradstone Cotswold and Conservation ranges to provide a traditional style swept valley. The Left Hand (LH) and Right Hand (RH) large and small wing slates will be selected and cut to shape on site to correspond and tie in with the normal slate length and coursing of the roof.

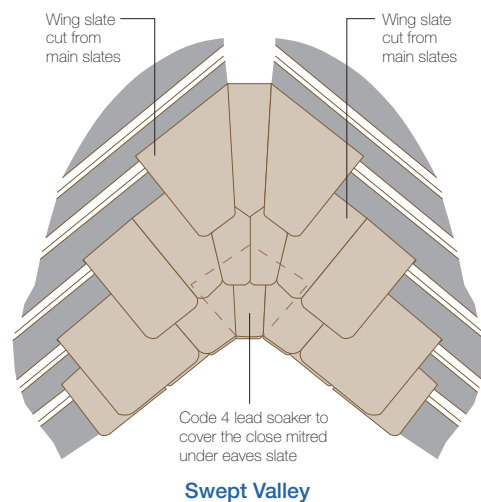
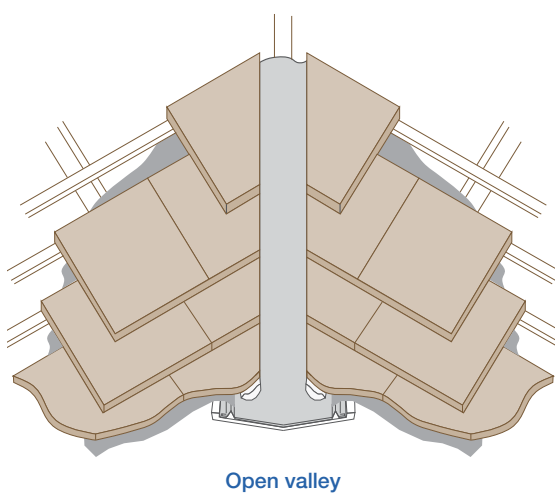
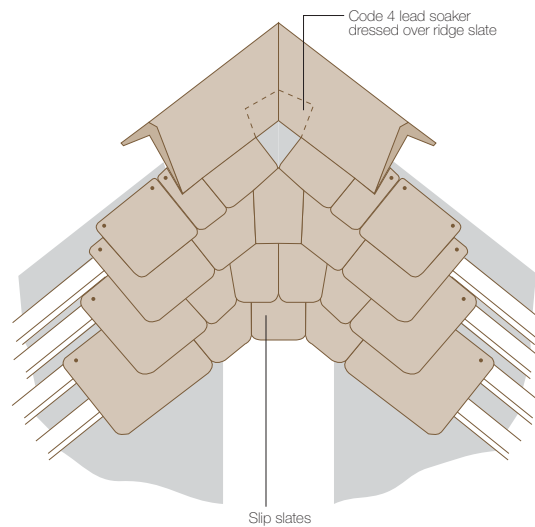
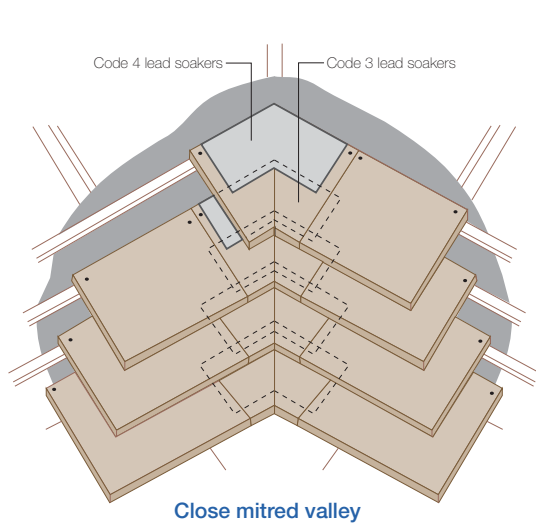

## Valleys at eaves

The valley should be felted and battened as for a standard mitred valley. A layboard, approximately 250mm wide for intersection of main roofs and 100mm wide for intersection of smaller features such as dormer windows, should be fixed up the valley to provide a support for the slates.

The first course at eaves will consist of large wing slate, LH; single slip slate; large wing slate, RH.

The second course from eaves will consist of small wing slate, LH; two slip slates; small wing slate, RH.

This is repeated throughout the length of the valley.

## For Cotswold Slates

	Length of slate (mm)	Wing slate (LH) cut on site	Centre slip slate	Wing slate (RH) cut on site
Ridge	300	small	51 51	small
	300	large	51	large
	350	small	50 50	small
	350	large	50	large
	400	small	49 49	small
	400	large	49	large
	450	small	48 48	small
	450	large	48	large
	500	small	47 47	small
	500	large	47	large
	550	small	46 46	small
Eaves	550	large	46	large

## For Conservation Slates

	Length of slate (mm)	Wing slate (LH) cut on site	Centre slip slate	Wing slate (RH) cut on site
Ridge	254	small	J J	small
	254	large	J	large
	279	small	H H	small
	279	large	H	large
	305	small	G G	small
	305	large	G	large
	330	small	F F	small
	330	large	F	large
	356	small	E E	small
	356	large	E	large
	406	small	D D	small
	406	large	D	large
	457	small	C C	small
	457	large	C	large
	508	small	B B	small
Eaves	508	large	B	large

Note: The first slate either side of the wing slate should be twice nailed. Centre slip slates are numbered. Wing slates are referred to as large or small depending upon their width and cut on site to suit roof pitch. When fixed they should alternate up the courses as the tables show to achieve adequate side laps.

# Ridge tile and slate ventilators

## Slate and ridge tile ventilators

Numerous factors in modern construction, including increased thermal requirements, have lead to an increased risk of condensation within roof spaces.

Average air temperatures within buildings have increased, allowing air to carry large quantities of vapour, while increased roof insulation has resulted in colder roof voids, increasing the risk of harmful condensation.

Condensation, taking place in roofs out of sight, can result in serious decay of structural roof timbers, reduced thermal performance of the insulant and damage to internal finishes.

Note: The slate ventilator must not be used as a gas flue or in conjunction with heating boilers.

## Slate ventilator

- Currently supplied in Conservation, Cotswold and Crofters formats
- Net free area: 10,000mm<sup>2</sup>
- Spacing centres to achieve ventilation are of:  
2.0m for 5,000mm<sup>2</sup>/m  
1.0m for 10,000mm<sup>2</sup>/m
- Minimum rafter pitch 30°

## Components

- One Cotswold slate (450x400mm), Conservation slate (406x375mm) or Crofters Sslate (550x25mm) ventilator
- One underlay protector
- Fixing instructions

## Airflow resistance (Pa):

Air flow resistance (Pa)	
54 <sup>3</sup> /m (15 litres/sec)	10
108 <sup>3</sup> /m (30 litres/sec)	10
216 <sup>3</sup> /m (60 litres/sec)	10

## Authority

Complies with:

- Mechanical ventilation to meet the requirements of the Building Regulations Approved Document F1: 1995 'Means of Ventilation'
- Roof void ventilation to comply with the Building Regulations Approved Document F2: 2006 'Condensation in Roofs'
- Soil pipe ventilation to comply with the Building Regulations Approved Document H1: 1992 'Sanitary Pipework and Drainage.'

A pipe adaptor is used to connect the ventilator to soil or mechanical ducting.

## Site fixing instructions

1. Determine the position of the ventilator between rafters. It will be necessary to remove a section of the batten, 256mm wide, where it would interfere with the throat of the ventilator.
2. An additional batten should be nailed to the rafters 25mm below the cut batten. The ends of the cut battens are supported by the cut batten support brackets provided, which are fixed to the additional batten.
3. Approximately 25mm above the batten immediately above the throat of the ventilator, cut a 340mm long slot in underlay to accept the underlay protector, which should pass under the batten and into the slot.

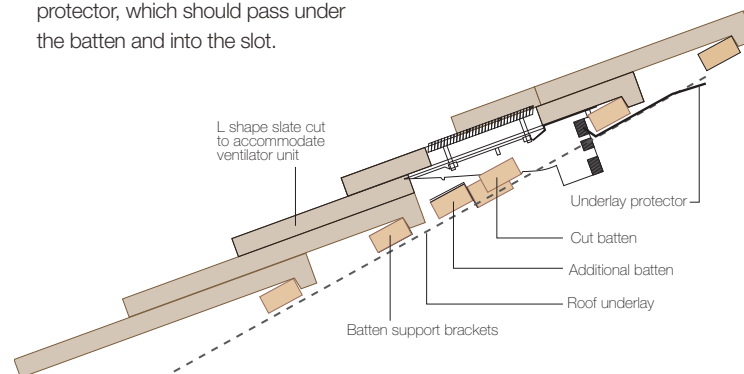

4. Cut the two slates in course directly

below the ventilator in an 'L' shape according to batten gauge, to accommodate ventilator unit. Select a slate for cutting that maintains required side lap cover. An additional fixing hole is recommended 15mm from cut edge.

5. Position the ventilator and mark an opening on the underlay. Cut and fold the flap upwards and outwards to accept the throat of the ventilator. Aperture size should be approximately 250mm wide by 55mm.
6. Place the throat of the ventilator through the underlay aperture to align with adjacent slates and nail twice into position.
7. The two slates directly above will require cutting to ensure that ventilator grille is not obstructed.
8. Continue slating as normal.
9. For soil pipe venting or mechanical extraction, attach the Bradstone Slate Pipe Adaptor and flexible pipe (supplied separately) after installation of ventilator.

# Ridge tile and slate ventilators

## Ridge tile ventilators

- Authentic look to the ridge line
- Complies with current building regulations
- Technical assistance available
- Supplied in Cotswold, Old Quarried, Crofters and Conservation ranges

Note: Bradstone ventilators must not be used for the extraction of hot combustion gases - see Bradstone gas flue ridge units.

### Product specification

- Material: Concrete ridge tile bonded to an ABS ventilator underbase unit
- Free ventilation area 10,000mm<sup>2</sup>
- Spacing centres to achieve ventilation are of: 2.0m for 5,000mm<sup>2</sup>/m

### Components

- One ridge ventilator unit to suit Cotswold, Old Quarried, Crofters or Conservation roofs
- One extension sleeve
- Fixing instructions

### Authority

Complies with:

- Roofscape Ventilation - Building Regulations Approved Document F2 : 2006 'Condensation in Roofs' BS5250 : 1989 Code of Practice for Control of Condensation in Buildings.

- Mechanical fixing - BS 5534 2014 Code of Practice for Slating and Tiling.
- Soil pipe ventilation - Building Regulations Approved Document H: 2002 'Sanitary Pipework and Drainage'.
- Mechanical ventilation - Building Regulations Approved Document F1 : 1995 'Means of Ventilation' BS 5720 : 1979 Code of Practice for Mechanical Ventilation and Air Conditioning in Buildings.

### Technical specification

- Driving rain resistant - test results to meet worst UK conditions.
- Integral 4mm large insect protection.
- Designed and developed under BS EN ISO 9001/9002.
- Integral stainless steel fixing wires for increased security.
- AA fire rating to BS 476: Part 3: 1958

The latest BRE advice is outlined in Good Building Guide 37 and BS5250, which states that ventilation, should always be provided either above or below permeable roof underlays and below impermeable underlays.

Bradstone slate and ridge tile ventilators can be used on new, refurbishment and re-roofing projects.

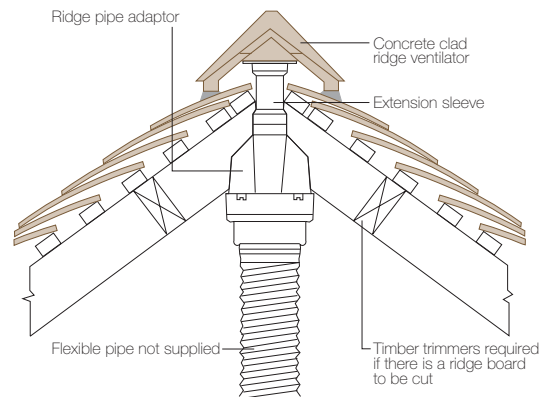

Ridge ventilator installed as soil vent or mechanical extract terminal (Installation required in unheated roof space)

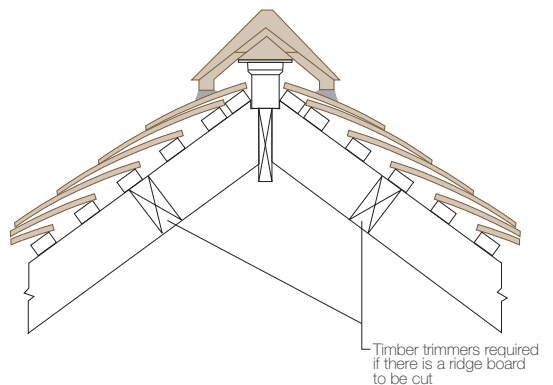

Ridge ventilator installed for roof space ventilation

### Airflow resistance (Pa):

	Pipe diameter (mm)			
	Old Quarried 110°		Cotswold / Conservation 90°	
	100	125	100	125
54 m <sup>3</sup> /hr (15 litres/sec)	4.0	4.8	2.0	2.6
108 m <sup>3</sup> /hr (30 litres/sec)	15.8	18.0	7.6	9.6
216 m <sup>3</sup> /hr (60 litres/sec)	62.6	70.5	28.7	36.0

Ventilator every 2 metres of ridge to provide 5,000mm<sup>2</sup> per metre at ridge

# Gas flue ridge terminal

## Description

The terminal primarily comprises two inverted vee section tiles, separated by integral corner pillars, the resulting side and end openings incorporate stainless steel square mesh bird guards.

## Composition

Produced in semi-dry concrete with stainless steel inserts.

## Size

Three versions, all 440mm in length.

- 90° Internal angle unit to suit Bradstone Cotswold roofing ridge
- 110° Internal angle unit to suit Bradstone Old Quarried and Crofters roofing ridge
- 90° Internal angle unit to suit Bradstone Conservation roofing ridge

## Installation

When fixing, remove a section of the ridge board 400mm long. Trimmer boards should be fixed to the adjacent rafters either side of the gap to maintain the structural stability of the roof at this juncture.

Both the 90° and 110° gas flue ridge terminals are fitted with two stainless steel bolts with nuts and washers which pass through the assembly (positioned at 330mm centres) and protrude beyond the lower ridge. These provide attachment points for an 'R' type adaptor (not provided) which in turn connects to the flue pipe. Both the pipe and adaptor are readily available from most builders' roofing merchants.

The gas flue ridge terminal should be bedded in mortar. Similar to the standard ridge units.

## Location

The gas flue ridge terminal should be positioned so that:

- Air may pass freely across and through it at all times
- It is at least 600mm from any opening in the building (including ventilation ridge terminals)
- Combustion gases released cannot re-enter the building through a window or air inlet above the ridge line
- The gas flue is at least 25mm clear of all combustible materials

Note: It is unlikely that snow or wind blown debris such as leaves may collect and block air passages.

## Declaration

A typical sample of this gas flue ridge terminal has been tested by BG Technology Certification Services and is certified to comply with the relevant requirements of BS 1289: Part 1: 1986, when tested at parameters pertaining to a 125mm diameter flue.

It is technically suitable for inclusion in the BG plc list of flues and terminals.

The tests carried out relate only to gas application of the unit.

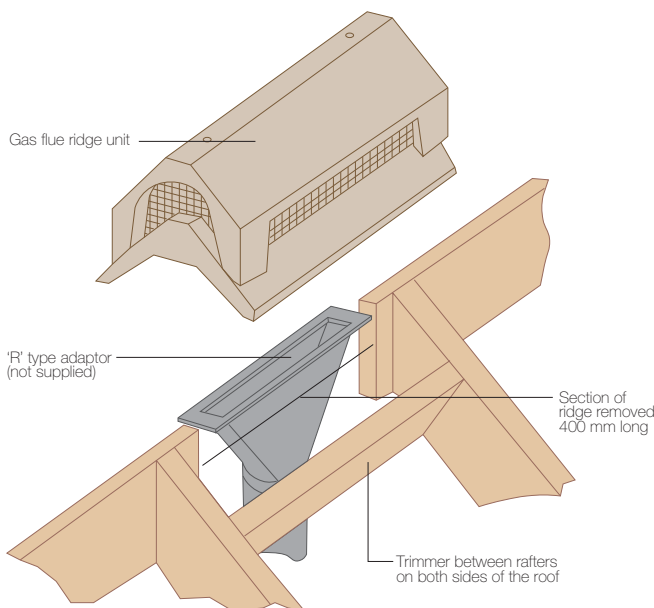



# Fixing information

## Check dimensions

Check the original drawings and the specific battening and coursing schedule against the actual rafter lengths, eaves oversail and other critical site dimensions. This is preferably done prior to delivery of materials to site.

## Battening: min. 50mm x 25mm

Batten out roof from eaves to ridge in accordance with the battening schedule (see 'Check dimensions' above). Tie-in battens on intersecting roofs (e.g. dormers etc.) with those of main roof when indicated in the battening schedule. Roofs of different pitches cannot be tied in and small dormers are normally coursed independently.

## Slating

Slates should be laid in diminishing lengths except Bradstone Crofters Slates and random widths in accordance with the coursing schedule supplied by Aggregate Industries for the particular roof.

Valleys and hips should be cut and fixed first along with the verges and then the main slatework filled in, working away from these sections in accordance with good roofing practice.

A good side bond should be maintained at all times and should never be less than 75mm for all types of roofing slates.

Note: Access to upper roof areas should be gained by ladders suitably padded to prevent damage to lower areas already slated.

## Underlays

The underlay should be in accordance with the relevant British Standards and laid to the manufacturers recommendations.

## Cutting and drilling

Aggregate Industries roofing slates can be easily cut when necessary by the same methods as those used for ordinary concrete tiles, the two most satisfactory methods being (a) the electric abrasive

disc-type cutter or, for Bradstone Cotswold and Conservation Slates only, (b) the manually operated tile cutter.

The tile cutter has the advantage of flexibility in that it can cut to a curve. Additionally, it gives a roughened appearance to the cut edge, which is more appropriate for a traditional material such as this.

In all cases only the widest size slates should be cut.

Bradstone roofing slates may be easily drilled with the use of an appropriate masonry drill.

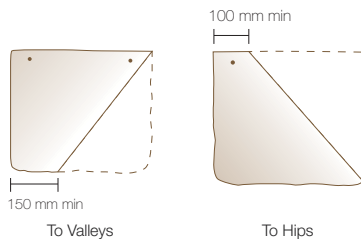

## General fixing methods

Bradstone Cotswold and Conservation Slates are simply hung over the batten by means of the continuous nib formed along the top edge of each slate specifically for the purpose.

Bradstone Old Quarried and Crofters Slates are hung using a stout nail or metal peg, e.g. 40mm long x 4.5 or 5mm aluminium tile pegs, located through the two holes at the head of each slate.

In all cases a certain number of slates and all perimeter slates should be twice nailed:

## At verges and on each side of valleys, hips and abutments

The last slate in each course should be twice nailed.

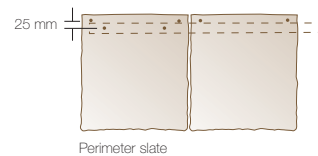

With moderate exposure we would also recommend twice nailing a certain number of the courses depending on the roof pitch:

## Pitches below 50°

Each slate twice nailed at every 5th course.

## Pitches 50-55°

Each slate twice nailed at every 3rd course.

## Pitches above 55°

Each slate twice nailed at every course.

In locations of extreme exposure, it is recommended that all slates are twice nailed rather than hung.

A good quality nail, such as aluminium alloy, should be used.

For the main slating, 40mm clout headed nails to BS 1202 are recommended. Longer nails may be needed in some parts of the roof, such as the eaves.

When nailing, care should be taken to ensure that slates, and particularly the wider slates, are not nailed down too tightly.

# Fixing information

For moderate exposure, local areas (see diagram) requires each tile to be double nailed.

## At Eaves

At Eaves and Top edge, two courses of tiles (consisting of undereaves course and full course at eaves, last full course and top course at top edges) should be nailed or otherwise mechanically fixed.

## At verges

At verges and abutments, and at each side of valleys and hips, the end tile in every course should be twice nailed (see diagram showing local areas requiring all tiles to be twice nailed).

**The above recommendations for severe exposure are in accordance with BS 5534:2014, however we recommend that for severe exposure, all slates are twice nailed.**

## Ridge and Hip Tiles

All ridge and hip tiles are to be mechanically fixed, using a minimum screw diameter of 4.5mm, penetrating at least 35mm into the batten.

Note: When Bradstone Old Quarried Slates are fixed using a combination of nailing and hanging, it will be necessary to make adjustments to the battening gauge.

In the courses which are nailed, the gauge specified in the battening guide must be reduced by half the width of the batten.

For example, in the case of a 50x25mm size batten the gauge should be reduced by 25mm.

In courses which are hung, Bradstone Old Quarried Slates must nevertheless be nailed at perimeters. In these cases it is necessary to drill holes for nails 25mm below the existing holes, as illustrated above.

## Duopitch and hipped roofs

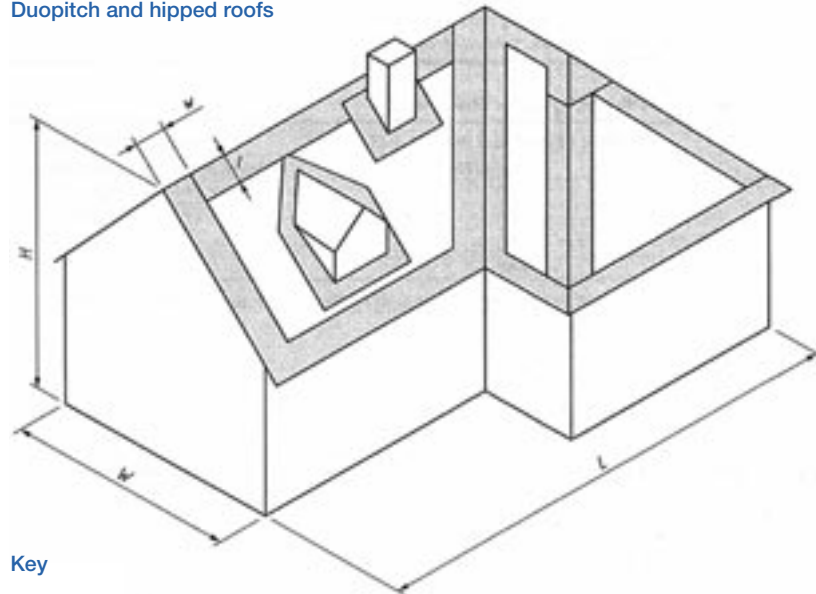

### Key

- Local areas
- General areas

# Aggregate Industries

## The complete service

Aggregate Industries is a leading player in the construction industry.  
We produce and supply a wide range of construction materials including:



### Aggregates

We supply crushed rock, sand and gravel, stone and fill materials for construction. These can be delivered by road, rail or marine transport. We also produce silica and specialist sands.

**Tel:** 01455 285200

**Email:** aggregates@aggregate.com



### Contracting

We strengthen our construction materials portfolio through our involvement in infrastructure, surfacing and civil contracting works.

**Tel:** 01530 510066

**Email:** contracting@aggregate.com



### Asphalt

We are a leading supplier of a full range of coated materials with over 40 locations in the UK, serving major conurbations, including sites for collect business.

**Tel:** 0844 557 8396

**Email:** asphalt@aggregate.com



### Garden landscaping

Bradstone is one of the UK's leading ranges of natural and reconstituted stone paving, walling, edging and coping, block paving and decorative aggregates.

**Tel:** 01335 372222

**Email:** bradstone.garden@aggregate.com



### Commercial landscaping

Flag paving, block paving and kerb products are available in both concrete and natural stone. Surface water drainage products are also part of a wide ranging portfolio.

**Tel:** 01335 372222

**Email:** landscaping@aggregate.com



### Concrete

We offer a complete range of ready-mixed concretes and screeds, operating from over 70 sites. We also have an operation that caters for smaller collect loads.

**Tel:** 01283 714187

**Email:** concrete@aggregate.com



### Overseas

Aggregate Industries Overseas supplies high quality aggregates to Europe from bases in the UK, Poland, Germany, Norway and Latvia.

**Tel:** 01530 512025

**Email:** overseas.sales@aggregate.com



### Cementitious materials

Lafarge Cement offers a wide variety of bulk and packed cementitious materials, produced at our cement plants in Cauldon, Staffordshire and Cookstown, County Tyrone.

**Tel:** 01455 288392

**Email:** cementitious@aggregate.com

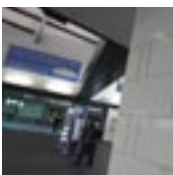

### Building products

We produce decorative masonry building blocks, reconstructed stone walling, architectural cast stone dressings and roofing slates.

**Tel:** 01285 646884

**Email:** building.products@aggregate.com

Aggregate Industries, North End Farm Works,  
Ashton Keynes, Wiltshire SN6 6QX

Tel: 01285 646900

Fax: 01285 646891

[www.aggregate.com](http://www.aggregate.com)

